



## R65FRx AND R65FKx RSC FORTH DEVELOPMENT AND KERNEL ROMS

### INTRODUCTION

The Rockwell Single Chip (RSC) FORTH System can be configured using the R65F11, R65F12 microcomputers or the R6501Q ROM-less microcomputer. One of these microcomputers, when used in conjunction with a development ROM and a FORTH kernel ROM, provide the designer with maximum flexibility when developing FORTH applications.

RSC-FORTH is based on the popular fig-FORTH model with extensions. The R65F11 and R65F12 both have the kernel of the high level Rockwell Single Chip RSC-FORTH language contained in the preprogrammed ROM. The R65FK2 and R65FK3 Kernel ROMs are preprogrammed ROMs for use with the R6501Q when developing larger applications requiring more memory and I/O line support. All of the run time functions of the RSC-FORTH are contained in these ROMs, including 16- and 32-bit mathematical, logical and stack manipulation, plus memory and input/output operators. The RSC-FORTH Operating System allows an external user program written in RSC-FORTH or Assembly Language to be executed from external EPROM, or development of such a program under the control of the R65FR1, R65FR2 or R65FR3 RSC-FORTH Development ROMs.

This document describes five different RSC-FORTH system configurations using the development and kernel ROMs.

### ORDERING INFORMATION

Part No.	Description
R65FR1P	FORTH Development ROM for R65F11 or R65F12
R65FR2P	FORTH Development ROM for R6501Q
R65FR3P	FORTH Development ROM for R6501Q
R65FK2P	FORTH Kernel ROM for R6501Q
R65FK3P	FORTH Kernel ROM for R6501Q
R65F11P	40-Pin FORTH Based Microcomputer at 1 MHz
R65F11AP	40-Pin FORTH Based Microcomputer at 2 MHz
R65F12Q	64-Pin FORTH Based Microcomputer at 1 MHz
R65F12AQ	64-Pin FORTH Based Microcomputer at 2 MHz
R6501Q	64-Pin One-Chip Microprocessor at 1 MHz
R6501AQ	64-Pin One-Chip Microprocessor at 2 MHz
Order No.	Description
2145	R6501Q One-Chip Microprocessor Product Description
2146	R65F11 and R65F12 FORTH Based Microcomputer Product Description
2148	RSC-FORTH User's Manual
2162	Application Note: A Low-Cost Development Module for the R65F11 FORTH Microcomputer

### FEATURES

- R65FR1 FORTH Development ROM
  - 8K ROM
  - Addressable from \$2000 through \$3FFF in FORTH development configuration memory map
  - R65F11 and R65F12 compatible
  - Operates in the R65F11/F12 FORTH development configuration
- R65FR2 FORTH Development ROM
  - 8K ROM
  - Addressable from \$4000 through \$5FFF in the FORTH development configuration memory map
  - R6501Q compatible for use in emulation of the R65F11/F12 FORTH development configuration
- R65FR3 FORTH Development ROM
  - 8K ROM
  - Addressable from \$C000 through \$DFFF in the FORTH development configuration memory map
  - Operates in the R6501Q FORTH development configuration
- R65FK2 FORTH Kernel ROM
  - 4K ROM
  - Addressable from \$F400 through \$FFFF in the FORTH development configuration memory map
  - R6501Q compatible for use in the emulation of the R65F11/F12 FORTH development configuration
  - Replaces the FORTH kernel contained in the R65F11 and R65F12 microcomputers during development
- R65FK3 FORTH Kernel ROM
  - 4K ROM
  - Addressable from \$F400 through \$FFFF in the FORTH development and production configuration memory maps
  - R6501Q compatible
  - Operates in the R6501Q FORTH development and production configurations

### RSC-FORTH SYSTEM CONFIGURATIONS

The three configurations of the RSC-FORTH System are identified by the CPU-Development ROM combinations listed below:

RSC-FORTH System Configurations

CPU	Kernel ROM	Development ROM	RSC Configuration
R65F11	none	R65FR1	1
R65F12	none	R65FR1	1
R6501Q	R65FK2	R65FR2	2
R6501Q	R65FK3	R65FR3	3

**RSC-FORTH CONFIGURATION 1 (R65FR1)**

**R65F11/R65F12 DEVELOPMENT AND PRODUCTION**

The RSC-FORTH Configuration 1 provides the designer with a FORTH development and application environment at a minimal cost. The application program is developed using an R65F11 or R65F12 microcomputer, an R65FR1 Development ROM and external RAM. Up to 8K bytes of RAM space is available using this configuration. However, Configuration 1 is limited to 5K or less bytes of RAM during development. This is the result of allocating 2K bytes of RAM for disk buffers and at least 1K bytes of RAM for the "Program heads". The program heads are contained in a dictionary containing the Name (NFA), Link Field Address (LFA) and the Parameter Field Address Pointer (PFA). This dictionary is a list of FORTH word words and user-defined FORTH words used in the development of a FORTH program and is not present during the execution of the FORTH program.

Although programs may reside in the upper 8K bytes of memory area, normally filled by the R65FR1 Development ROM, it is difficult to develop code for that area using this configuration of the RSC-FORTH System.

The difference in using the R65F11 or the R65F12 is in the number of I/O lines available to the user. The R65F11 supports 16 I/O lines, the R65F12 supports 40 I/O lines.

Figure 1 shows the development and production configurations for the R65F11/F12. Configurations 1A and 1B list the features, memory maps, and the relationship of the R65F11 and R65F12 to the R65FR1 Development ROM in the development and production environment.

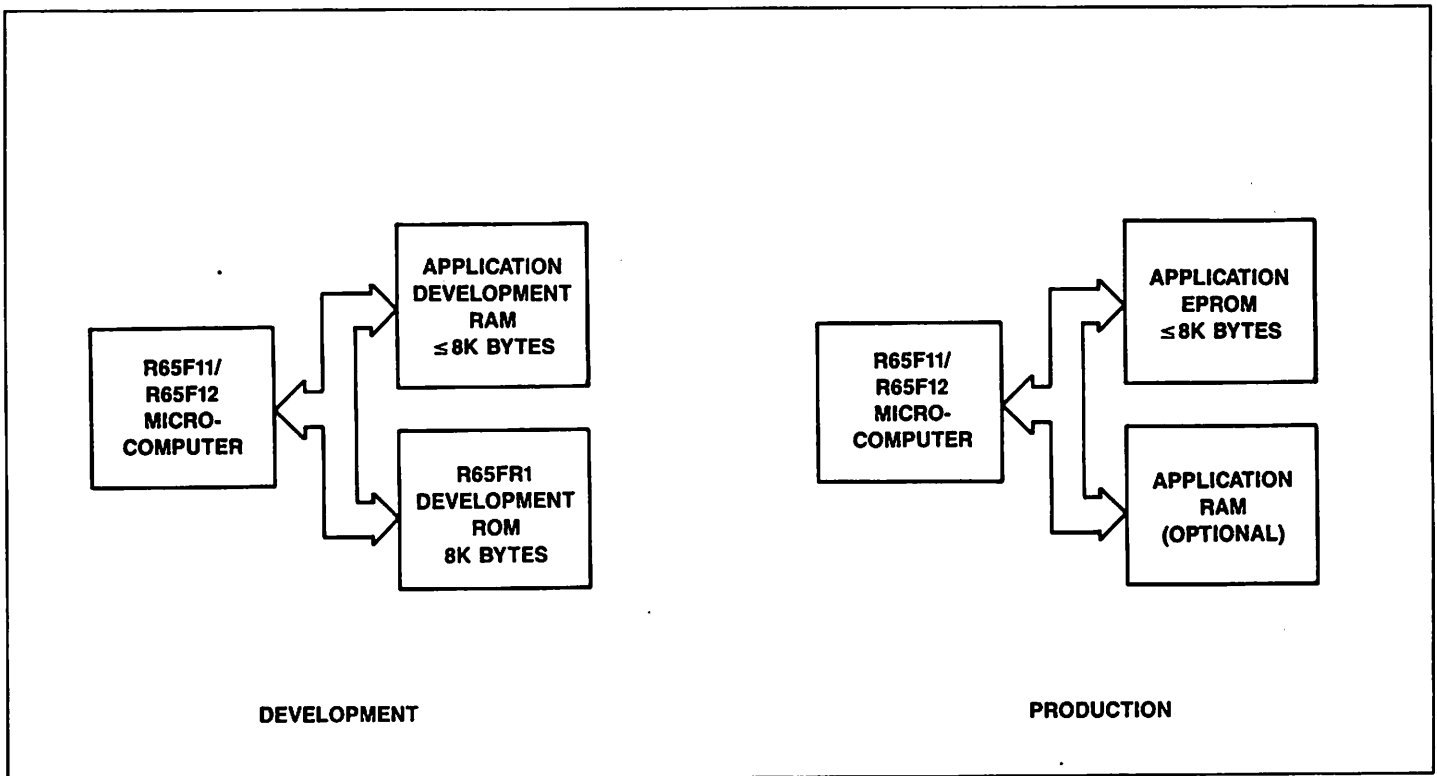

Figure 1. R65FR1 Configuration 1 Block Diagram

**CONFIGURATION 1A CONSIDERATIONS**

Features

- 8K Bytes of User Memory
- 16 I/O Lines

Device Configuration

DEVELOPMENT PRODUCTION

R65F11 Microcomputer	✓	✓
R65FR1 Development ROM	✓	

**CONFIGURATION 1B CONSIDERATIONS**

Features

- 8K Bytes of User Memory
- 40 I/O Lines

Device Configuration

DEVELOPMENT PRODUCTION

R65F12 Microcomputer	✓	✓
R65FR1 Development ROM	✓	

**User Memory—I/O Resource Matrix**

User memory may be a mix of ROM, EEROM, UVPR0M or RAM.

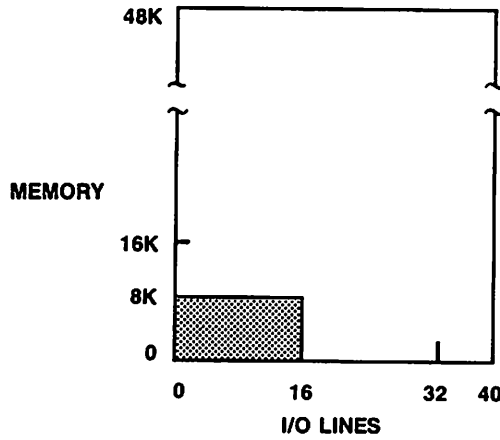

**User Memory—I/O Resource Matrix**

User memory may be a mix of ROM, EEROM, UVPR0M or RAM.

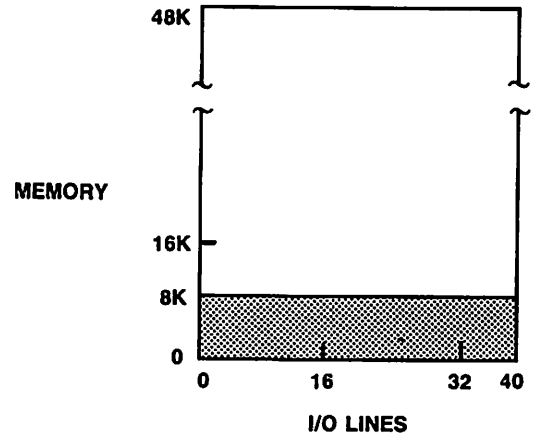

**Memory Map**

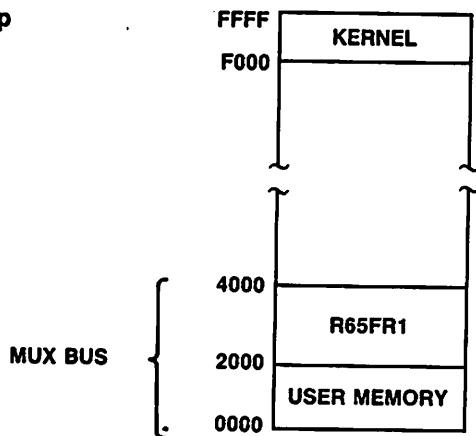

**Memory Map**

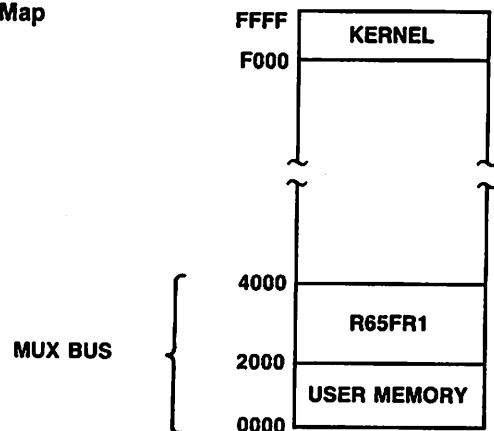

**RSC-FORTH CONFIGURATION 2  
(R65FR2, R65FK2)**

**R6501Q DEVELOPMENT AND R65F11/F12  
PRODUCTION**

The RSC-FORTH Configuration 2 provides the designer with the capability of using the full 16K bytes of external address space of the R65F11 and R65F12.

The R6501Q ROM-less microprocessor, when used with the R65FK2 Kernel ROM and the R65FR2 Development ROM, emulates the operation of the R65F11/F12. Because of the greater address space of the R6501Q, the R65FR2 Development ROM can be relocated to address \$4000 and the disk buffers and HEADS program to \$6000. This expands the available user memory space to 16K bytes, \$0000 through \$3FFF.

Using this configuration, the application program can be developed using the R6501Q and then later installed in an R65F11 or R65F12 microcomputer without modification.

Figure 2 shows the development and production configuration for the R6501Q. Configurations 2A and 2B list the features, memory maps, and the relationship of the R6501Q to the R65FR2 Development ROM and R65FK2 Kernel ROM in the development and production environment. Figure 3 is a schematic of the R6501Q, R65FR2, R65FK2 development setup.

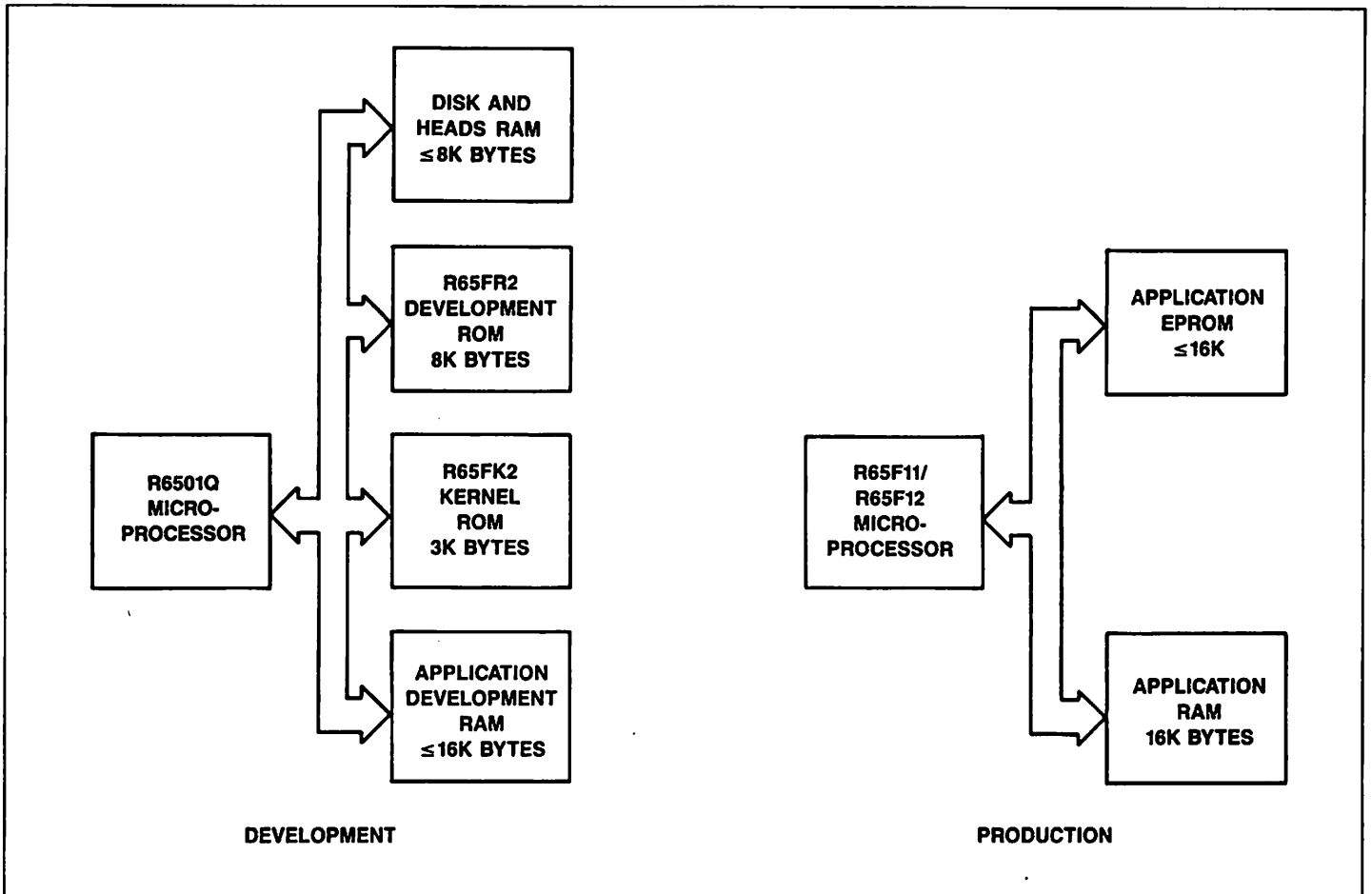

Figure 2. R65FR2 and R65FK2 Configuration 2 Block Diagrams

**CONFIGURATION 2A CONSIDERATIONS**

**Features**

- 16K Bytes of User "Headerless" Memory
- 16 I/O Lines

**Device Configuration**

	DEVELOPMENT	PRODUCTION
R65F11 Microcomputer		✓
R6501Q Microprocessor	✓	
R65FR2 Development ROM	✓	
R65FK2 Kernel ROM	✓	

**Memory—I/O Matrix**

If floppy disk is used in the application, space for the disk buffers must be allocated in memory from \$0500 through \$3FFF or \$6000 through \$7FFF. User memory can be a mix of ROM, EEROM, UVROM or RAM.

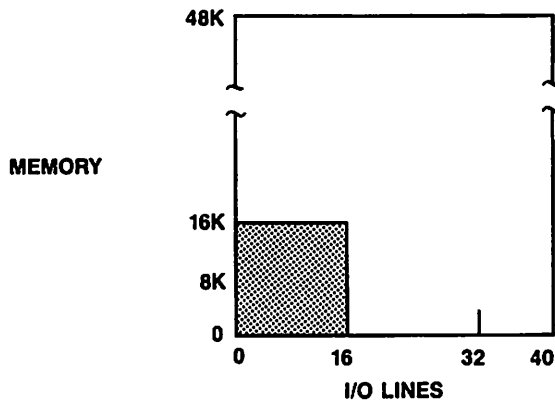

**Memory Maps**

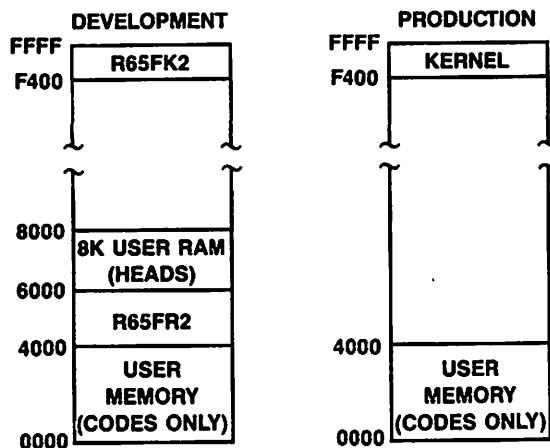

**CONFIGURATION 2B CONSIDERATIONS**

**Features**

- 16K Bytes of User "Headerless" Memory
- 40 I/O Lines

**Device Configuration**

	DEVELOPMENT	PRODUCTION
R65F12 Microcomputer		✓
R6501Q Microprocessor	✓	
R65FR2 Development ROM	✓	
R65FK2 Kernel ROM	✓	

**Memory—I/O Matrix**

If floppy disk is used in the application, space for the disk buffers must be allocated in memory \$0000 through \$3FFF. User memory can be a mix of ROM, EEROM, UVROM or RAM.

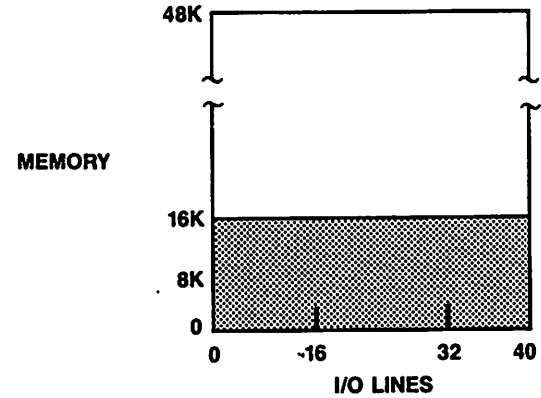

**Memory Maps**

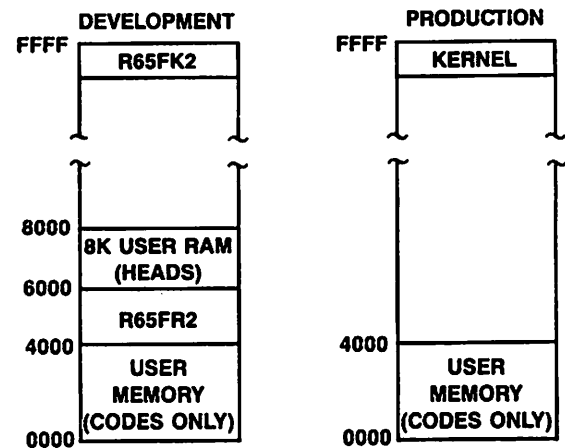

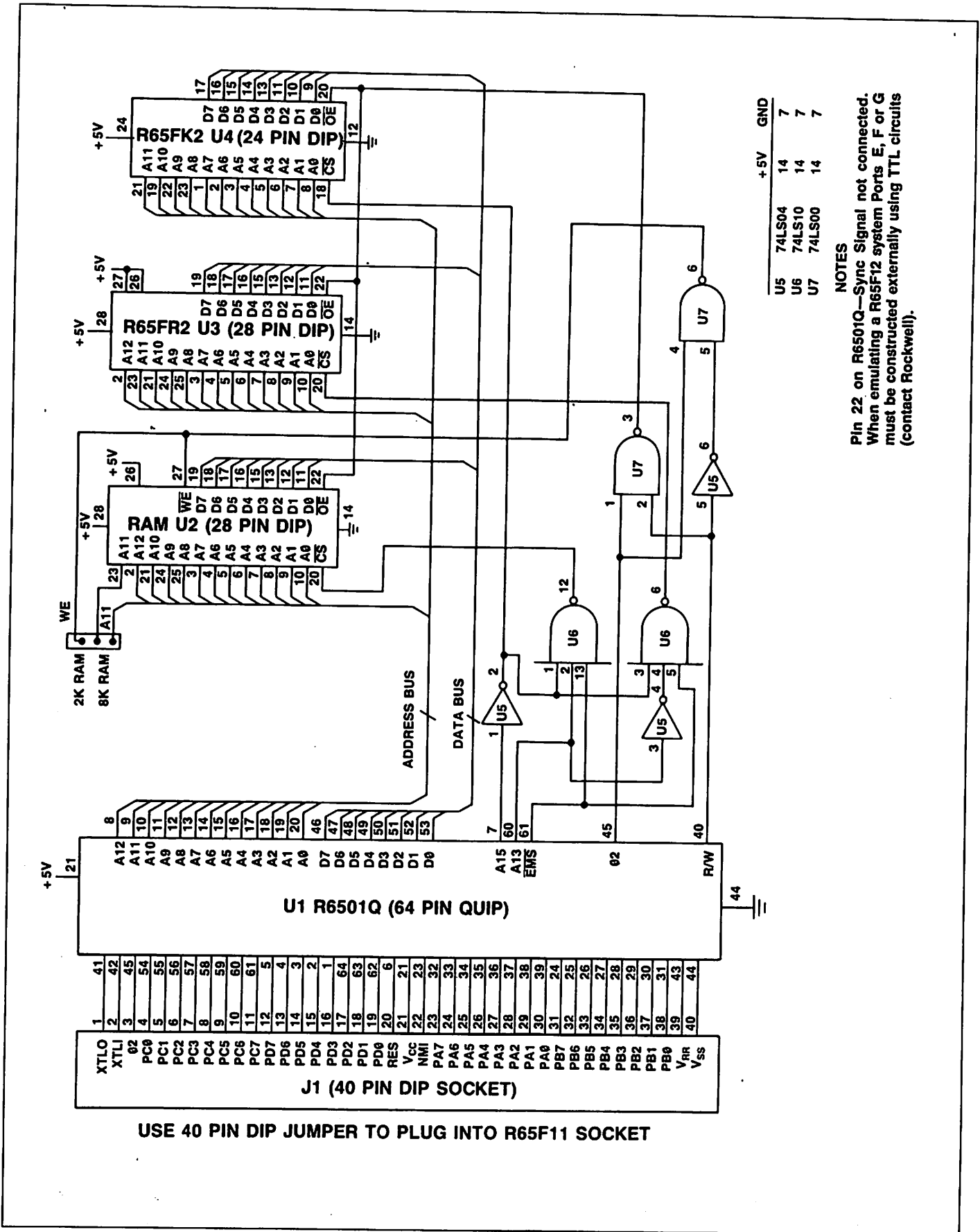

Figure 3. R6501Q, R65FR2 and R65K2 Application Configuration Schematic

**RSC-FORTH CONFIGURATION 3  
(R65FR3, R65FK3)**

**R6501Q BASED SYSTEM DEVELOPMENT  
AND PRODUCTION**

The RSC-FORTH Configuration 3 is designed for those applications which require a larger amount of ROM or RAM space than the R65F11 or R65F12 can provide.

In the development configuration, the user is provided with up to 48K bytes of memory. The user memory is located from \$0000 through \$BFFF. The program heads will use some of this area but the user will still have considerably more memory space available than in the previous configurations.

The production configuration provides up to 56K bytes of user memory. This is due to the fact that the R65FR3 Development ROM, used in the development configuration, is not required in the production configuration and releases the 8K bytes of memory space. This memory is located at \$C000 through \$DFFF.

Figure 4 shows the development and production configurations for the R6501Q. Configuration 3 lists the features, memory maps, and the relationship of the R6501Q to the R65FR3 Development ROM and the R65FK3 Kernel ROM in the development and production environment.

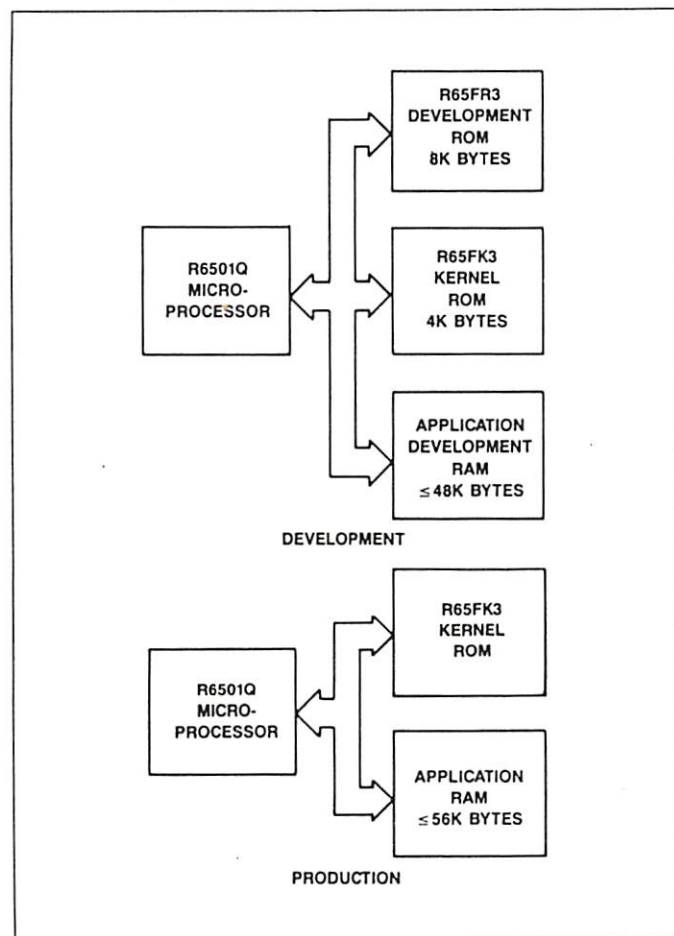

Figure 4. R65FR3 and R65FK3 Configuration 3 Block Diagrams

**CONFIGURATION 3 CONSIDERATIONS**

Features

- R6501Q w/FORTH
- 48K Bytes of User Memory
- 30 I/O Lines

Device Configuration

	DEVELOPMENT	PRODUCTION
R6501Q Microcomputer	✓	✓
R65FK3 Development ROM	✓	
R65FR3 Kernel ROM	✓	✓

User Memory—I/O Resource Matrix

All ports act as I/O ports. Memory is on the bus. PC6 & PC7 (I/O lines) are assigned to memory. User memory can be a mix of ROM, EEROM, UVPR0M or RAM.

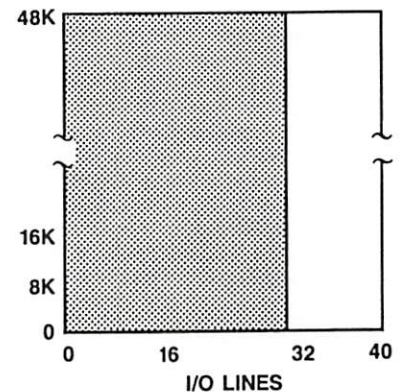

Memory Maps

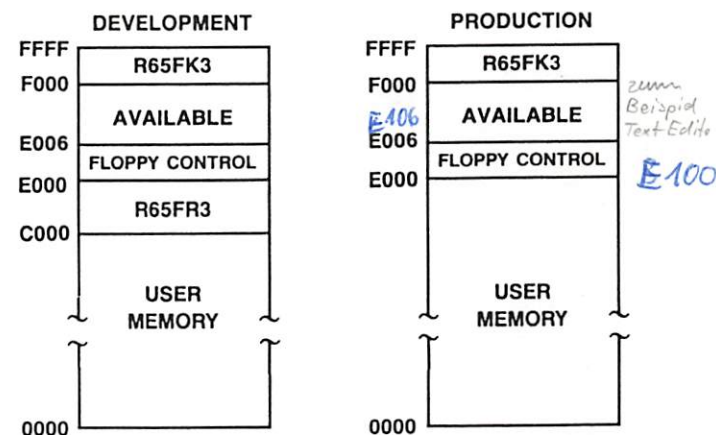



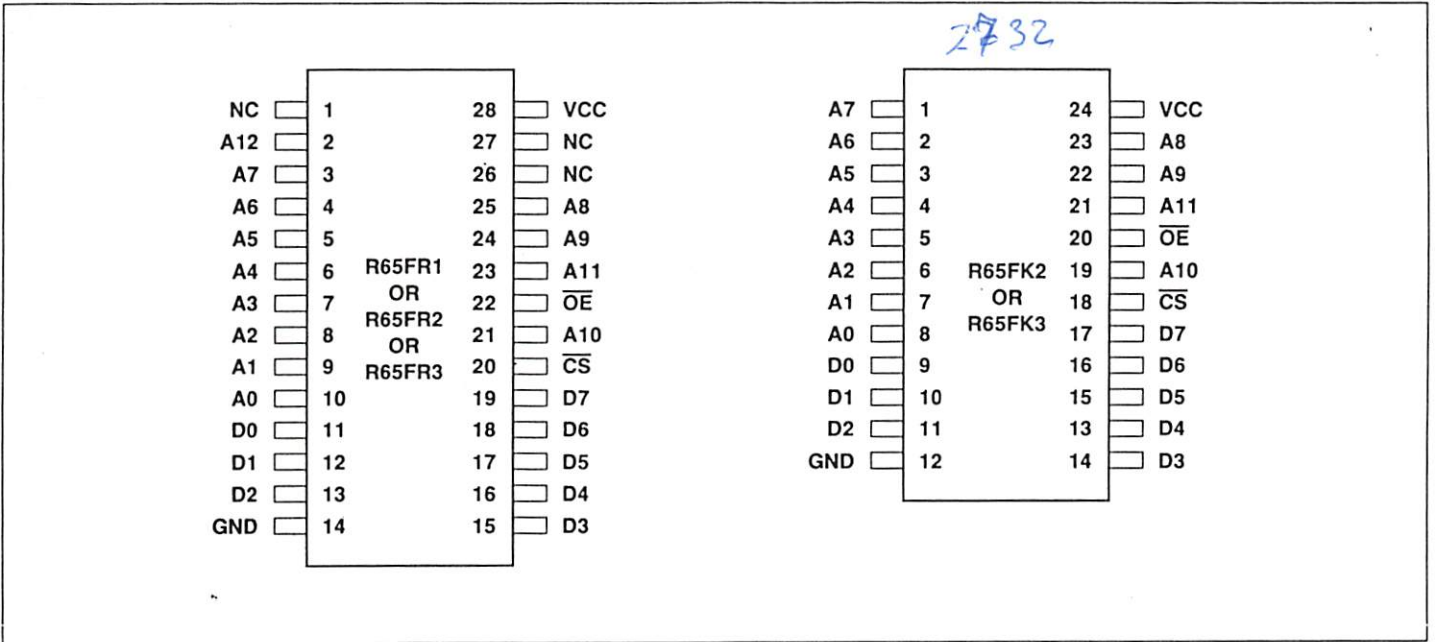

RSC-FORTH ROM Pin Assignments

Information furnished by Rockwell International Corporation is believed to be accurate and reliable. However, no responsibility is assumed by Rockwell International for its use, nor any infringement of patents or other rights of third parties which may result from its use. No license is granted by implication or otherwise under any patent or patent rights of Rockwell International other than for circuitry embodied in a Rockwell product. Rockwell International reserves the right to change circuitry at any time without notice. This specification is subject to change without notice.

©Rockwell International Corporation 1984  
All Rights Reserved

Printed in U.S.A.

SEMICONDUCTOR PRODUCTS DIVISION REGIONAL ROCKWELL SALES OFFICES

**HOME OFFICE**

Semiconductor Products Division  
Rockwell International  
4311 Jamboree Road  
P O Box C, MS 501-300  
Newport Beach, California  
92658-8902  
(714) 833-4700  
TWX: 910 591-1698

**UNITED STATES**

Semiconductor Products Division  
Rockwell International  
1842 Reynolds  
Irvine, California 92714  
(714) 833-4655  
TWX: 910 595-2518

Semiconductor Products Division  
Rockwell International  
3375 Scott Blvd., Suite 410  
Santa Clara, California 95051  
(408) 980-1900

Semiconductor Products Division  
Rockwell International  
921 Bowser Road  
Richardson, Texas 75080  
(214) 996-6500  
TLX: 73-307

Semiconductor Products Division  
Rockwell International  
10700 West Higgins Rd., Suite 102  
Rosemont, Illinois 60018  
(312) 297-8862  
TWX: 910 233-0179 (RI MED ROSM)

Semiconductor Products Division  
Rockwell International  
5001B Greentree  
Executive Campus, Rt. 73  
Marlton, New Jersey 08053  
(609) 596-0090  
TWX: 710 940-1377

**FAR EAST**

Semiconductor Products Division  
Rockwell International Overseas Corp.  
Itohpa Hira-kawa-cho Bldg.  
7-6, 2-chome, Hira-kawa-cho  
Chiyoda-ku, Tokyo 102, Japan  
(03) 265-8806  
TLX: J22198

Rockwell Collins International  
Tai Sang Commercial Bldg., 11th Floor  
24-34 Hennessy Rd.  
Hong Kong  
(5) 274-321  
TLX: 74071 HK

**EUROPE**

Semiconductor Products Division  
Rockwell International GmbH  
Fraunhoferstrasse 11  
D-8033 Munchen-Martinsried  
West Germany  
(089) 857-6016  
TLX: 0521/2650 rimd d

Semiconductor Products Division  
Rockwell International  
Heathrow House, Bath Rd.  
Cranford, Hounslow,  
Middlesex, England  
(01) 759-9911  
TLX: 851-25463

Semiconductor Products  
Rockwell Collins Italiana S.P.A.  
Via Boccaccio, 23  
20123 Milano, Italy  
(02) 498.74.79  
TLX: 316562 RCIMIL 1

**YOUR LOCAL REPRESENTATIVE**

R65FR3P  
2000-3FFF auf Disk  
R65FK3P  
4000-4FFF auf Disk